

COATINGS:
 FRAMEWORK—COATED PER (ASTM-F-1043) TYPE A
 EXPANDED METAL PANELS 4' OR 5' WIDE X FENCE HEIGHT
 1"-7 OR 3/4"-9 REVERSED DIAMOND
 FITTINGS—GALVANIZED PER (ASTM-A153)
 TOP RAIL=263 LBS @ MID POINT OF 10'-0" SPAN

PHYSICAL PROPERTIES:

DIMENSIONS	3.25" x 2.50"	WALL THICKNESS	0.150"	WEIGHT PER FOOT	5.40#	SECTION MODULUS	1.25	YIELD STRENGTH	60,000	MAX. BENDING MOMENT LB. IN.	75,000
------------	---------------	----------------	--------	-----------------	-------	-----------------	------	----------------	--------	-----------------------------	--------

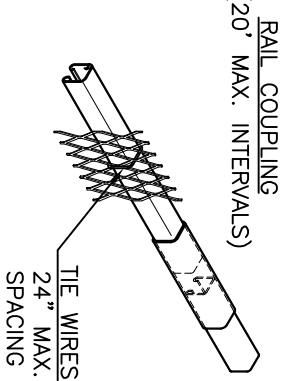
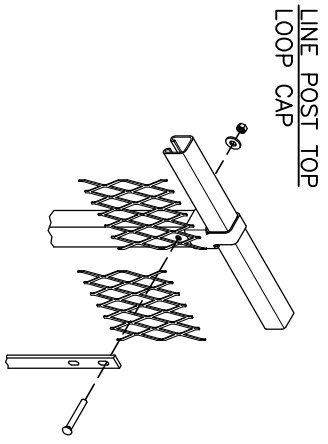
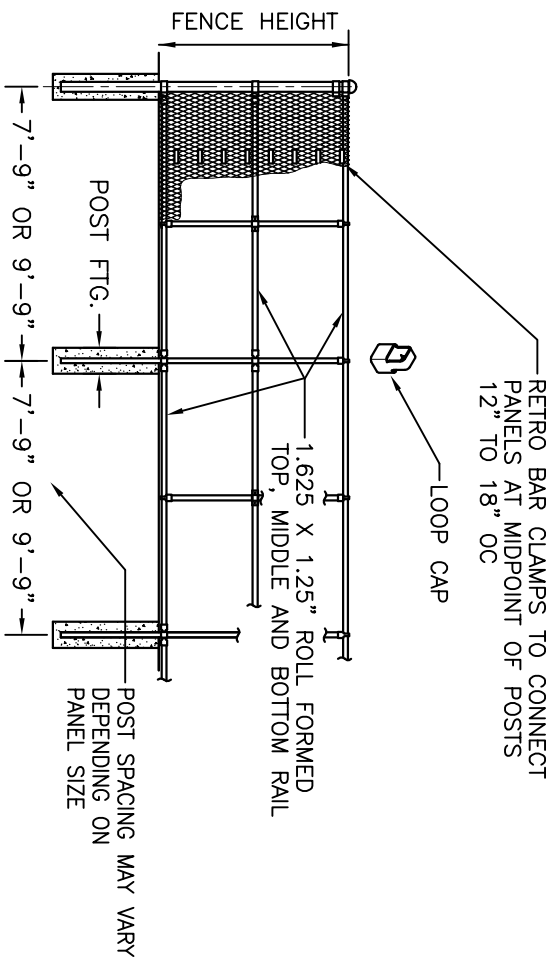
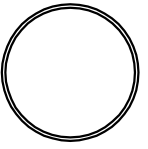
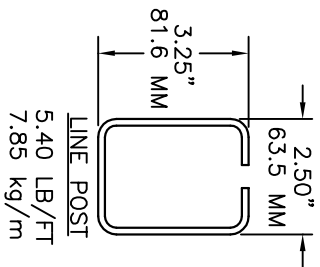
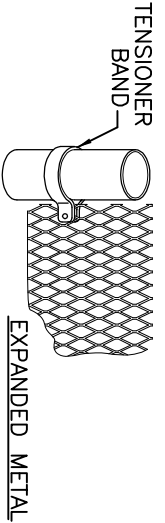
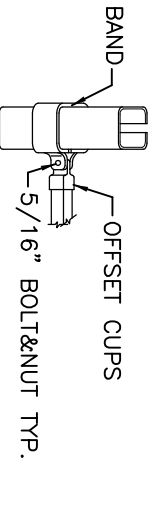
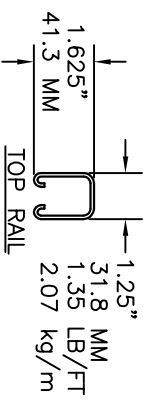
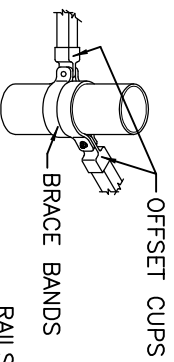
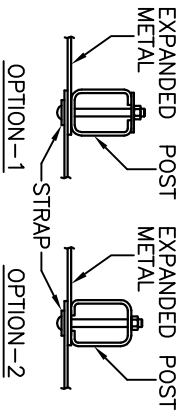
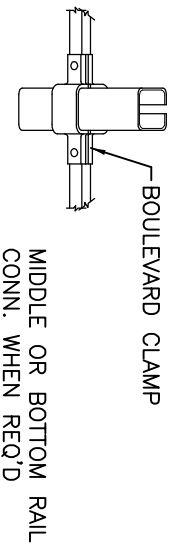

THIS DRAWING IS THE PROPERTY OF GREGORY FENCE PRODUCTS AND IS LOANED WITHOUT OTHER CONSIDERATION THAN THE AGREEMENT AND CONDITION THAT IT IS NOT TO BE REPRODUCED OR OTHERWISE DISPOSED OF DIRECTLY OR INDIRECTLY, AND IS NOT TO BE USED IN WHOLE OR IN PART TO ASSIST IN MAKING OR TO FURNISH ANY INFORMATION FOR THE MAKING OF DRAWINGS, PATENTS, APPARATUS OR PARTS THEREOF. THESE DRAWINGS SHALL BE RETURNED TO GREGORY FENCE PRODUCTS UPON REQUEST. THE ACCEPTANCE OF THIS DRAWING WILL BE CONSTRUED AS AN ACCEPTANCE OF THE FOREGOING CONDITIONS AND AN ASSIGNMENT OF THE EXCLUSIVE OWNERSHIP IN AND TO THE DRAWING OF GREGORY FENCE PRODUCTS.

ITEM	QNT'Y	DESCRIPTION	MATERIAL
SCALE	NONE	CHK'D BY	DWN BY
CAD FILE NAME:		SUPER 'C' POST WITH EXPANDED METAL (NO BARB WIRE)	
GGM9-001		DWN BY IDI 03-27-10 APP'D BY	
LAST PLOT DATE:		REF. NO.	
04-19-10		DRWG NO.	
		GGM9-01	
		GREGORY FENCE PRODUCTS	
		4100 13TH STREET S.W. CANTON, OHIO 44708	

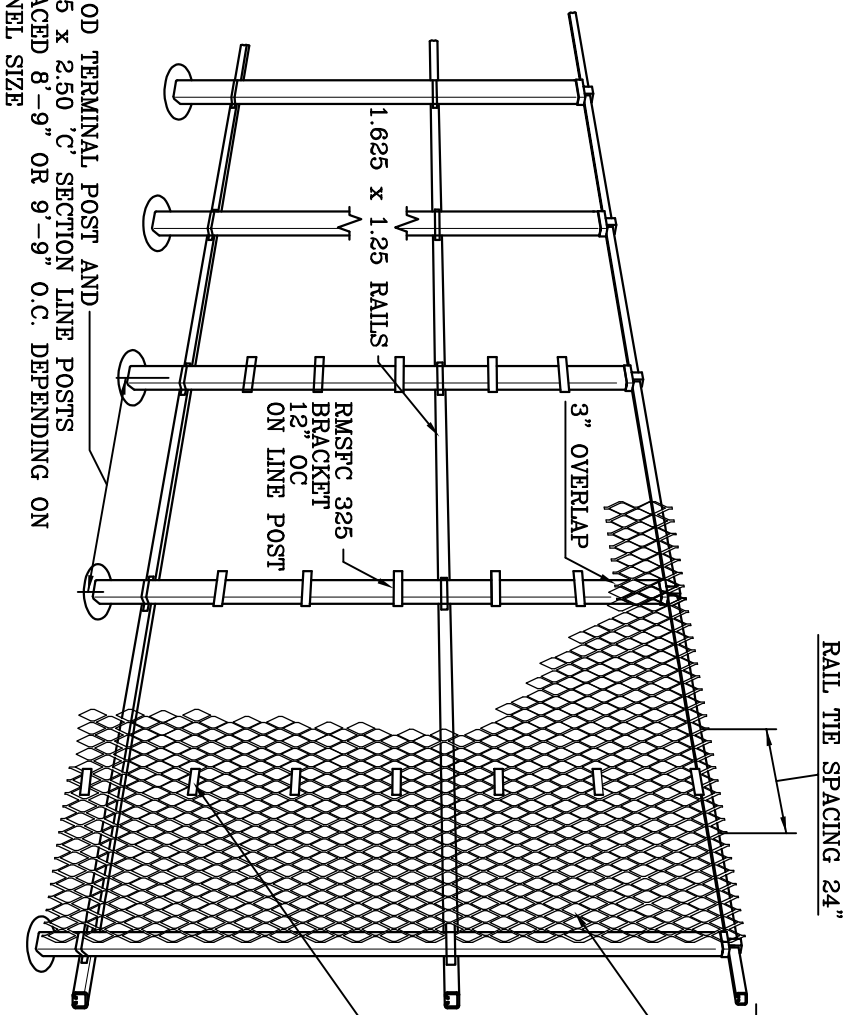

RAIL THE SPACING 24"

1"-7" EXPANDED METAL OR
3/4"-9" EXPANDED METAL
REVERSED DIAMOND

2 PC PANEL CONNECTING
BRACKET 12" TO 18" OC

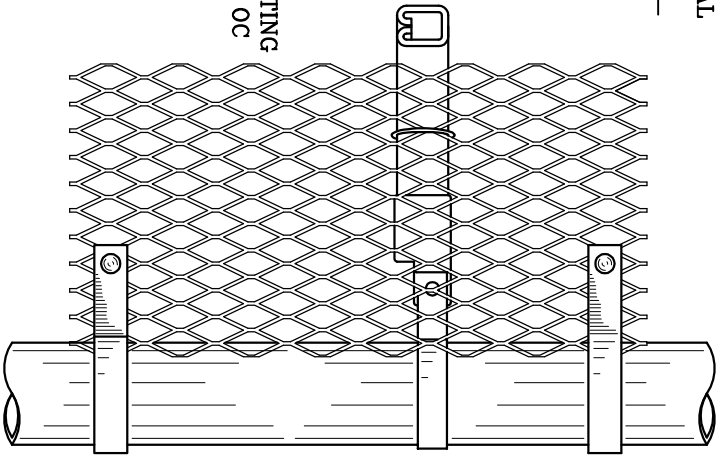

CORNER CONNECTION

4" OD TERMINAL POST AND
3.25 x 2.50 'C' SECTION LINE POSTS
SPACED 8'-9" OR 9'-9" O.C. DEPENDING ON
PANEL SIZE

10 GA. x 1" MINIMUM FLAT BAR RMSFC 325
FORMED AS SHOWN

5/16-16 UNC x 1-1/2 LG.
CARRIAGE BOLTS AND NUTS
2 REQUIRED PER CLAMP

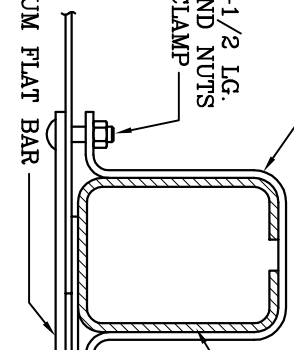

10 GA. x 1" MINIMUM FLAT BAR
RMSFC 325

3.25" x 2.50" ROLL FORMED
'C' SECTION POST
EXPANDED METAL
OVERLAP AT LINE POST
SQUARE HOLES
THIS SIDE TYP.

THIS DRAWING IS THE PROPERTY OF GREGORY FENCE PRODUCTS AND IS LOANED
WITHOUT OTHER CONSIDERATION THAN THE AGREEMENT AND CONDITION THAT IT IS
NOT TO BE REPRODUCED OR OTHERWISE USED BY ANY OTHER PARTY WITHOUT THE
WRITTEN PERMISSION OF GREGORY FENCE PRODUCTS. ANY INFORMATION FOR THE MAKING OF
DRAWINGS, PRINTS, REVISIONS OR PARTS THEREOF SHALL BE RETURNED TO GREGORY FENCE
PRODUCTS UPON REQUEST. THE ACCEPTANCE OF THIS DRAWING WILL BE CONSIDERED AS AN
ACCEPTANCE OF THE FOREGOING CONDITIONS AND AN ASSIGNMENT OF THE EXCLUSIVE
OWNERSHIP IN AND TO THE DRAWING OF GREGORY FENCE PRODUCTS.

ITEM	QNT'Y	DESCRIPTION	MATERIAL
SCALE NONE CHK'D BY DWN BY IDI 03-27-10 APP'D BY			
SUPER 'C' POST WITH EXPANDED METAL AND RMSFC 325 CLAMPS			
CAD FILE NAME: GGM9-02			
LAST PLOT DATE: 04-08-10			
GREGORY FENCE PRODUCTS		4100 13TH STREET S.W. CANTON, OHIO 44708	
REF. NO. GGM9-02		DRWG NO.	

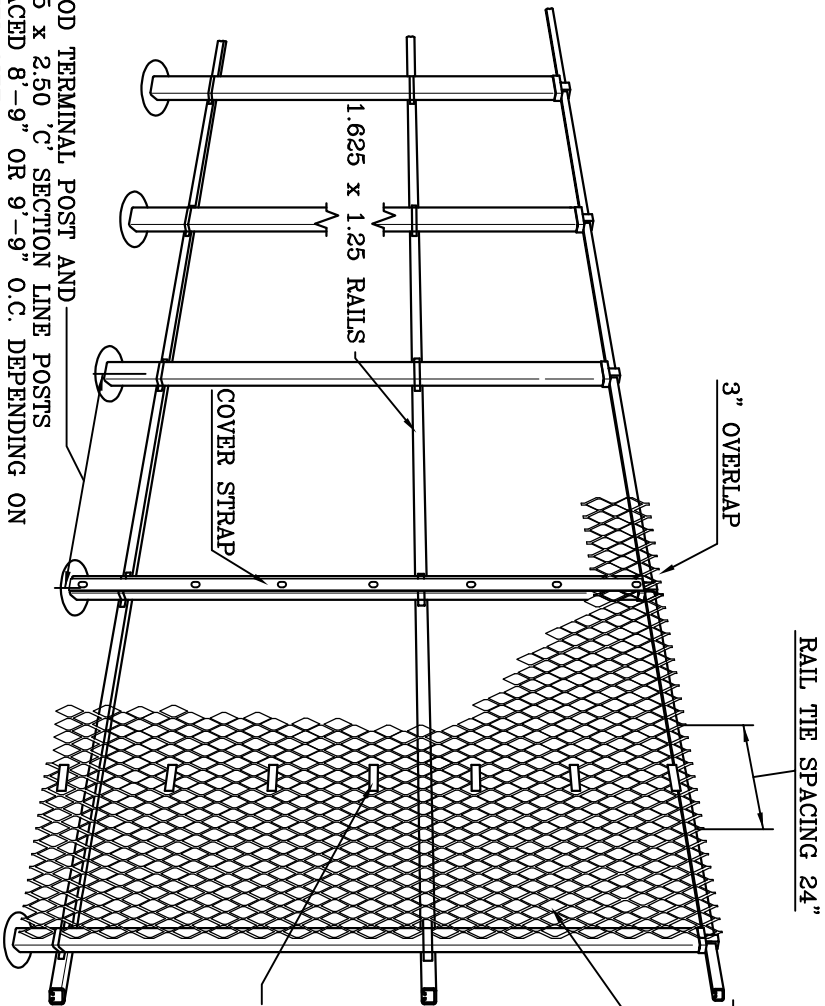

RAIL THE SPACING 24"

1"-7" EXPANDED METAL OR
3/4"-9" EXPANDED METAL
REVERSED DIAMOND

1.625 x 1.25 RAILS

COVER STRAP

2 PC PANEL CONNECTING
BRACKET 12" TO 18" OC

CORNER CONNECTION

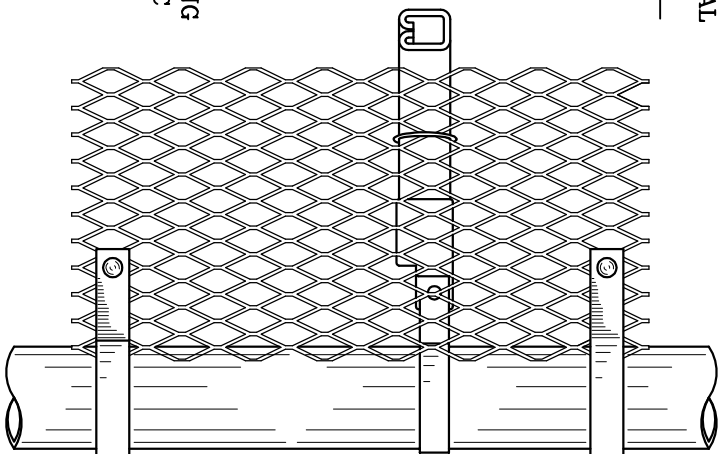

4" OD TERMINAL POST AND
3.25 x 2.50 'C' SECTION LINE POSTS
SPACED 8'-9" OR 9'-9" O.C. DEPENDING ON
PANEL SIZE

3" OVERLAP ON EXPANDED
METAL PANELS

3/16 X 2" STEEL COVER STRAP
W/SLOTS 12" OC

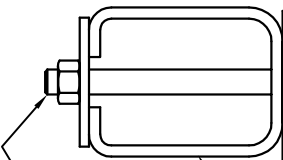

3/8 X 4 1/2"
BOLT & NUT-12" OC

THIS DRAWING IS THE PROPERTY OF GREGORY FENCE PRODUCTS AND IS LOANED
WITHOUT OTHER CONSIDERATION THAN THE AGREEMENT AND CONDITION THAT IT IS
NOT TO BE REPRODUCED OR OTHERWISE DISPOSED OF DIRECTLY OR INDIRECTLY,
AND IS NOT TO BE USED IN WHOLE OR IN PART TO ASSIST IN MAKING OR TO FURNISH
ANY INFORMATION FOR THE MAKING OF DRAWINGS, PRINTS, MAPPINGS OR PATENT
THAT ARE NOT TO BE RETURNED TO GREGORY FENCE PRODUCTS UPON
REQUEST. THE ACCEPTANCE OF THIS DRAWING WILL BE CONSTRUED AS AN ACCEPTANCE
OF THE FOREGOING CONDITIONS AND AS AN ASSIGNMENT OF THE EXCLUSIVE
OWNERSHIP IN AND TO THE DRAWING OF GREGORY FENCE PRODUCTS.

ITEM	QNT'Y	DESCRIPTION	MATERIAL
SCALE NONE CHK'D BY DWN BY IDI 03-27-10 APP'D BY			
SUPER 'C' POST WITH EXPANDED METAL AND COVER STRAP			
CAD FILENAME: GGM9-03			
LAST PLOT DATE: 04-08-10			
GREGORY FENCE PRODUCTS		REF. No. GGM9-03	
4100 13TH STREET S.W.		DRAWG No.	
CANTON, OHIO 44708			